

EN | VALID FROM 01.03.2025 - 31.12.2025

GEDORE  red

IMPULSE²⁵

SELECTION

TOOL TROLLEY
MEISTER XXL

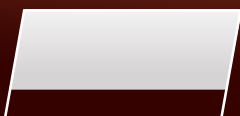

MINI WORK LAMP UV

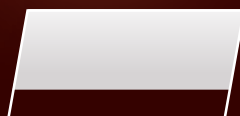

COMBINATION RATCHET
SPANNER SET

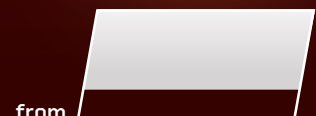

from

85 TOOLS, 17 HIGHLIGHTS AND INNOVATIONS



23 R2190 2072
PLUMBERS
TOOL TROLLEY

R2165 2089
TOOL CASE
ELECTRICIAN

24

















R9560 0320
INSPECTION
LAMP

39



CONTENTS

	RATCHET SPANNERS	04 – 07
	SOCKET SETS	08 – 24, 34, 36, 43
	BIKE-SETS	19
	RANGE OF SOCKETS	25
	TORQUE WRENCHES	26
	SCREWDRIVERS AND BITS	25, 27
	WORKSHOP EQUIPMENT	28 – 33
	STRIKING TOOLS	35
	PLIERS	42
	1000V	36
	WORK LAMPS	37 – 41
	CUTTING / FILING / DRILLING	42 – 43

R0512 6008

DOUBLE OPEN ENDED SPANNER SET

in wallet, 8 pieces

- > Acc. to DIN 895, ISO 3318, ISO 1085
- > Jaw set at 15°
- > In practical roll wallet



Code	No.	Length mm	Width mm	Height mm	Pieces	Weight kg
3301081	R05126008	235	60	60	8	0,64

Contents

Double open ended spanner 6x7 8x9 10x11 12x13 14x15 16x17 18x19 20x22 mm

R0510 5012

DOUBLE OPEN ENDED SPANNER SET

long, metric, 12 pieces

- > Acc. to DIN 3110, ISO 3318, ISO 1085, ISO 10102
- > Jaw set at 15°
- > In holder



Code	No.	Contents	Pieces	Weight kg
3300960	R05105012	Double open-end wrench 6x7 8x9 10x11 12x13 14x15 16x17 18x19 20x22 21x23 24x27 25x28 30x32 mm	12	2,42

R0720 30XX

COMBINATION RATCHET SPANNER SETS

- > In accordance with DIN 3113, ISO 3318
- > Ring offset to 15°, reversible for right and left hand operation
- > 72 teeth Ratchet mechanism
- > Return angle 5°
- > Jaw set at 15°
- > In rugged plastic case



from



Code	No.	Contents	Length mm	Width mm	Height mm	Pieces	Weight kg	excl. VAT
3300059	R07203012	Combination ratchet spanners 8 10 12 13 15 17 18 19 mm Square end drive adaptor 1/4" for 10 mm 3/8" for 13 mm, 1/2" for 19 mm Bit adaptor 1/4" for 10 mm	275	200	53	12	15,68	
3300060	R07203016	Combination ratchet spanners 8 9 10 11 12 13 14 15 16 17 18 19 mm Square drive adapter 1/4" for 10 mm 3/8" for 13 mm, 1/2" for 19 mm Bit adapter 1/4" for 10 mm	303	225	69	16	2,1	

R0590 5010

OPEN ENDED RATCHET SPANNER SET

metric, 10 pieces

- > In accordance with DIN 3318
- > Straight pattern
- > Open end with ratchet function
- > Jaw set at 15°
- > Ring side open, offset to 15°
- > In holder



Code	No.	Contents
3301003	R05905010	Open ended ratchet spanner 10 11 12 13 14 15 16 17 18 19 mm

Pieces	Weight kg
10	1,758

R0740 5006

DOUBLE ENDED RING RATCHET SPANNER SET

straight, metric, 6 pieces

- > In accordance with DIN 837
- > Straight pattern
- > 72 teeth Ratchet mechanism
- > In holder



Code	No.	Contents	Pieces	Weight kg
3300898	R07405006	Double ring ratchet spanner 8x9 10x11 12x13 14x15 16x18 17x19 mm	6	0,865

R0730 5005

FLEXIBLE HEAD COMBINATION RATCHET SPANNER SET

5 pieces

- > In accordance with DIN 3113, ISO 3318
- > With 180° swivel head
- > 72 teeth Ratchet mechanism
- > Return angle 5°
- > Jaw set at 15°
- > In holder



Code	No.	Contents	Pieces	Weight kg
3300890	R07305005	Flexible head combination ratchet spanner 8 10 13 17 19 mm	5	1,158

NEW

R0720 XXXX

COMBINATION RATCHET SPANNER

reversible with hold function

- > Hold function in the ratchet head for holding and safely guiding nuts or screws and bolts
- > According to ISO 21982
- > 15° angled ring ratchet head, reversible clockwise/ anticlockwise rotation
- > Ratchet mechanism with 72 teeth
- > Jaw set at 15°
- > Matt chrome-plated surface
- > Chromium vanadium steel



from



Code	No.	Width across flats mm	Length mm	Weight kg	excl. VAT
3301008	R07201080	8	138	0,03	
3301009	R07201090	9	150	0,04	
3301004	R07201100	10	161	0,063	
3301010	R07201110	11	165	0,07	
3301011	R07201120	12	165	0,08	
3301005	R07201130	13	183	0,103	
3301012	R07201140	14	190	0,12	
3301013	R07201150	15	199	0,13	
3301082	R07201160	16	209	0,14	
3301006	R07201170	17	225	0,19	
3301083	R07201180	18	235	0,21	
3301007	R07201190	19	245	0,243	

R0910 XXXX

COMBINATION SPANNER SET

metric

- > Acc. to DIN 3113, Form A, ISO 3318, ISO 7738
- > Jaw set at 15°
- > In holder



from



Code	No.	Pieces	Weight kg	excl. VAT
3300988	R09105008	8	0,6	

Contents
Combination spanner
8 9 10 11 13 14 17 19 mm

Code	No.	Pieces	Weight kg	excl. VAT
3300991	R09105021	21	4,712	

Contents
Combination spanner
6 7 8 9 10 11 12 13 14 15 16 17 18 19 20 21 22 24 27 30 32 mm

NEW

R0720 51XX

COMBINATION RATCHET SPANNER SET

reversible with hold function

- > Hold function in the ratchet head for holding and safely guiding nuts or screws and bolts
- > According to ISO 21982
- > 15° angled ring ratchet head, reversible clockwise/anticlockwise rotation
- > Ratchet mechanism with 72 teeth
- > Jaw set at 15°
- > Matt chrome-plated surface
- > Chromium vanadium steel

from



Innovative hold function in the ring ratchet head



Angled ring ratchet head



Code	No.	Contents	Pieces	Weight kg	excl. VAT
3301084	R07205106	8 10 12 13 17 19 mm	6	0,85	
3301085	R07205112	8 9 10 11 12 13 14 15 16 17 18 19 mm	12	1,8	

R3300 3043

TORSION BIT SET

43 pieces

- > 43-piece torsion bit set for a multitude of screw joints
- > Flexible bit screwdriver with ratchet function (for working in confined spaces)
- > Bits with torsion zone for high stresses
- > Easy to see size marking on bits for quick access
- > For manual and machine operation



Highly stressable torsion bits

Saves time: Size marking on the bits

Bendable bit screwdriver including ratchet



Code	No.	Length mm	Width mm	Height mm	Pieces	Weight kg
3304902	R33003043	250	140	52	43	0,985

Contents

- Ratchet screwdriver magnetic
- 1/4" Quick change adapter
- Bit adapter 1/4" hex x 1/4" square, L. 50mm
- Bit adapter 1/4" hex x 3/8" square, L. 50mm
- Socket, magnetic, with 1/4" hex drive 8 10 13 | 65mm
- 1/4" Torsion bits, 25mm:
 - PH1 (1x), PH2 (2x), 3 (1x) PZ1 (1x), PH2 (2x), 3 (1x), TX T10, T15, T20, T25, T30, T40
- Slotted 5.5, 6.5 mm
- 1/4" Torsion bits, 50mm:
 - PH1 (1x), PH2 (2x), PH3 (1x)
- Hexagon socket 3, 4, 5 mm
- PZ1 (1x), PZ2 (2x), PZ3 (1x), TX T10, T15, T20, T25, T30
- 1/4" Torsion bits, 90mm:
 - PH2 (1x), PZ2 (1x)
- Slotted 5.5 mm
- TX T25

R3300 3051

1/4" BIT SET

51 pieces

- > Set with common bit sizes and drive adapter with bit lock
- > Long bits
- > Reversible ratchet with 2C-handle and 5° return angle and reversible lever for convenient change of direction
- > Bit adapter enables alternative drive of the bits with the reversible ratchet



Code	No.	Length mm	Width mm	Height mm	Pieces	Weight kg
3301350	R33003051	230	130	52	51	0,98

Contents

1/4" Sockets 4 5 5.5 6 7 8 9 10 11 12 13 14 mm
1/4" Reversible ratchet
1/4" Extension 100mm
1/4" Adapter square x hexagon
1/4" Bits 25mm:
PH1 (1x), PH2 (2x), PH3 (1x), PZ1 (1x), PZ2 (2x), PZ3 (1x)
Slotted 4.4 5 6.5mm
TX T10 T15 T20 T25 T27 T30 T40
Hexagon socket 2 3 4 5 6 mm
Bit adapter 1/4" square x 1/4" hex
1/4" Bits 90mm:
PH1 (1x), PH2 (1x), PZ1 (1x), PZ2 (1x), TX T20 T25 T30
Hexagon socket 3 4 5 6 mm
Slotted 5.5mm

R3300 3067

1/4" BIT SET

67 pieces

- > Set with common bit sizes and drive adapter with bit lock
- > Long bits
- > Screwdriver with strong magnet for quick and easy bit replacement and ergonomic grip
- > Quick-change adapter enables quick bit changes

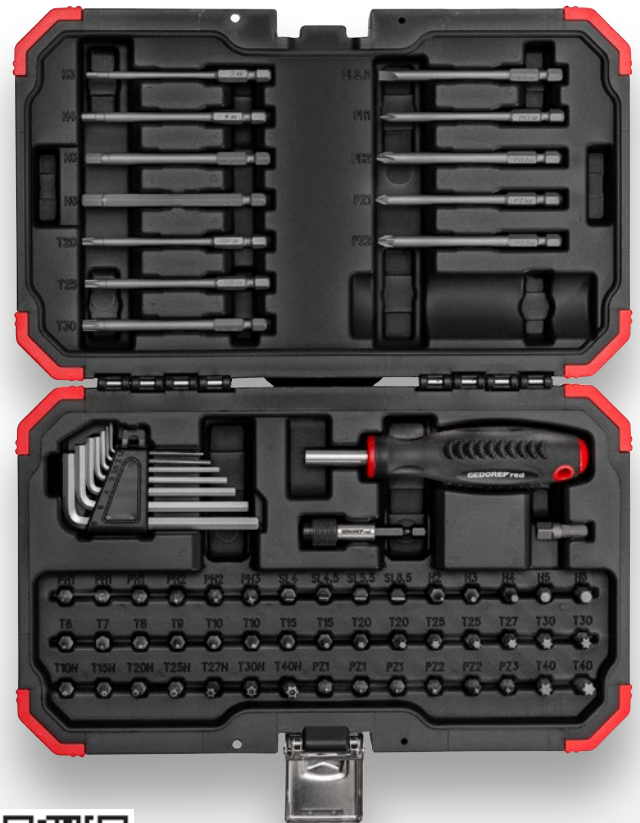

Code	No.	Length mm	Width mm	Height mm	Pieces	Weight kg
3301352	R33003067	300	180	52	67	1,1

Contents

Offset screwdriver set 1.5, 2, 2.5, 3, 4, 5, 6 mm
1/4" Magnetic bit screwdriver
1/4" Quick change adapter
1/4" Bits, 25mm:
PH1 (3x), PH2 (2x), PH3 (1x)
PZ1 (3x), PZ2 (2x), PZ3 (1x)
Slotted 4, 4.5, 5.5, 6.5mm
TX T6, T7, T8, T9, T10, T10, T15, T15, T20, T20, T25, T25, T27, T30, T30, T40, T40
TX T10H, T15H, T20H, T25H, T27H, T30H, T40H
Hexagon socket 2, 3, 4, 5, 6 mm
Bit adapter 1/4" square x 1/4" hex
1/4" bits, 90mm:
PH1 (1x), PH2 (1x), PZ1 (1x), PZ2 (1x)
TX T20, T25, T30
Hexagon socket 3, 4, 5, 6 mm
Slotted 5.5mm



R6900 3069

1/2" SERVICE SOCKET SET

69 pieces

> Ideal combination for jobs with service work

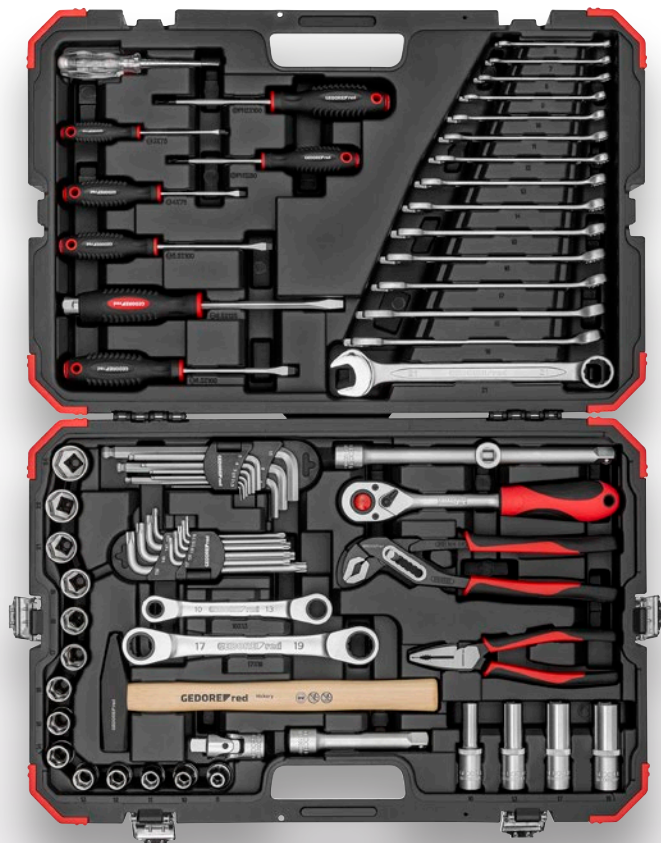

Code	No.	Length mm	Width mm	Height mm	Pieces	Weight kg
3300191	R69003069	552	360	100	69	9,9

Contents

2C reversible ratchet, right-hand/left-hand rotation can be switched by lever, push-button release, fine-toothed, oval head, 2-component handle, hand-friendly power transmission, for socket spanner inserts
 Socket, hexagonal, metric, short version to DIN 3124
 ISO 2725, SW 10 11 12 13 14 15 16 17 18 19 21 22 24 | 38 mm
 Socket spanner insert, hexagonal, metric, long version to DIN 3124
 ISO 2725, SW 10 13 17 19 | 77 mm
 Socket spanner extensions 1/2' L 125 250 mm
 Cardan joint 1/2', screwed joint, version to DIN 3123 - C 12.5
 Enlargement adapter/sliding piece 3/8' x 1/2', for driving socket spanner and screwdriver sockets
 Double ring ratchet spanner, straight form, metric
 fine-toothed SW10x13mm, SW17x19mm
 Combination spanner metric to DIN 3113, form A, ISO 3318, ISO 7738, jaw position 15°
 ring side angled 15°, SW 6 7 8 9 10 11 12 13 14 15 16 17 18 19 21
 Hexagon socket set, ball point, long, 9 pcs. 1.5-10mm
 Hex key L-wrench set TX. long, 9 pcs. T10-50
 Screwdriver slotted 3mm 0.5x75mm, 4mm 0.8x100mm
 5.5 1x100mm, 6,5mm 1,2x100mm,
 Screwdriver slotted, with impact cap 6.5mm 1.2x100mm
 Phillips PH1 L80mm, PH2 L100mm
 Phase tester, integrated glow lamp and series resistor for networks from 105- max. 250V
 Combination pliers 180 mm, gripping zones for flat and round material, 2-component handle, hand-friendly power transmission
 Water pump pliers, 7-position adjustable, polished head and joint, 2-component handle, hand-friendly power transmission
 Locksmith's hammer 300g





R6900 3061

1/2" SOCKET SET

61 pieces

> Ideal for all jobs for do-it-yourselfers



Code	No.	Length mm	Width mm	Height mm	Pieces	Weight kg
3300370	R69003061	452	340	86	61	7,14

Contents

R61000806 Socket insert 1/2 hexagon
8 9 10 11 12 13 14 15 16 17 19 21 22 24 mm | 38 mm
R60000027 2C-Reversible ratchet 1/2 L.250 mm Return angle 5°
R65300012 Cardan joint 1/2 L.66 mm
R61021612 Spark plug insert 1/2 16 18 21 mm | 65 mm
R65100024 Plug-in extension 1/2 L.125 250 mm
R57300008 Enlargement piece 3/8 x 1/2 square L.44 mm
R28100010 Water pump pliers 10" 7-way
R28302180 Combination pliers L.180 mm 2C-handle
R36605008 Offset screwdriver set hexagonal 1.5-8 mm 8 pcs
R36405008 Offset screwdriver set TX9-40 8 pcs
R92100020 Engineer's hammer 500g L.320 mm ash
R09100060 Combination wrench 6 7 8 9 10 11 12 13 14 15 16 17 18 19 mm
R38100315 2C-Screwdriver slot 3 mm
0.5x75 mm, 5.5 mm 1x100 mm, 8 mm 1,2x100 mm
R38200115 2C-Screwdriver PH1 L.80 mm, PH2 L.100 mm
R38120001 MOTORCYCLE Voltage tester 3-48 V



R4900 3016

SOCKET SET 1/4"

16 pieces

> For hand-operated applications



Code	No.	Contents	Length mm	Width mm	Height mm	Pieces	Weight kg
3300050	R49003016	1/4" 2C lever reversible ratchet, fine-toothed, 72 teeth 150 mm 1/4" Socket hexagon 4 4,5 5 5,5 6 7 8 9 10 11 12 13 25 mm 1/4" Socket extension 100 mm, 1/4" Sliding T-bar with slider 115 mm Bit adaptor 1/4" square x 1/4" hexagon 25 mm	190	115	54	16	0,62

R4900 3046

SOCKET SET 1/4"

46 pieces

> For hand-operated applications

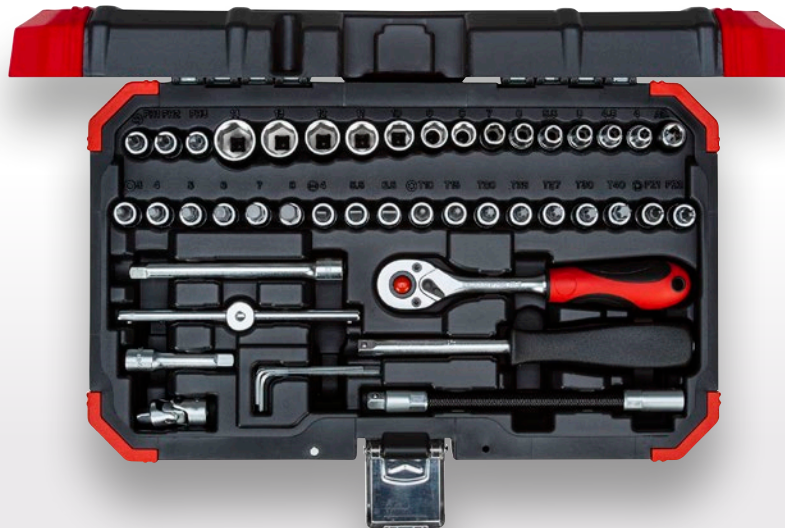

Code	No.	Length mm	Width mm	Height mm	Pieces	Weight kg
3300052	R49003046	298	185	54	46	1,414

Contents

1/4" 2C reversible lever ratchet fine-toothed, 72 teeth | 150 mm, 1/4" square socket 165 mm, 1/4" socket hexagon 4 4.5 5 5.5 6 7 8 9 10 11 12 13 14 | 25 mm
 1/4" screwdriver bit socket hexagon socket inner 3 4 5 6 | 37 mm, 1/4" screwdriver bit socket slot 4 5 5.5 6 5 | 37 mm, 1/4" Screwdriver bit socket Phillips PH 1 2 3 | 37 mm
 1/4" Screwdriver bit socket PZ 1 2 | 37 mm, 1/4" Screwdriver bit socket TX T15 T20 T25 T30 | 37 mm, 1/4" Socket wrench extension 50 100 mm
 1/4" Cardan joint | 32 mm Bit-Adapter, 1/4" square x 1/4" hexagon | 25 mm

R4600 3100

1/4" + 1/2" SOCKET SET

100 pieces

> Ideal for all screwdriving tasks during maintenance, in the trade or in the workshop

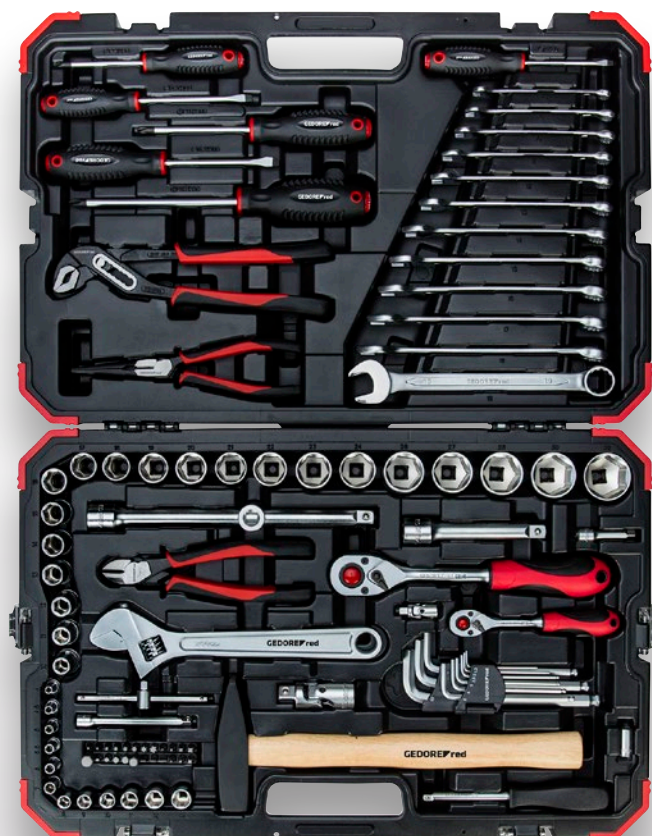

Code	No.	Length mm	Width mm	Height mm	Pieces	Weight kg
3300063	R46003100	348	365	105	100	10

Contents

1/4" 2C lever reversible ratchet, fine-toothed, 72 teeth | 150 mm
 1/4" square plug-in handle 165 mm
 1/4" socket hexagon 4 4.5 5 5.5 6 7 8 9 10 11 12 13 mm
 1/4" socket extension 50 100 mm
 1/4" sliding T-bar with slider | 115 mm
 1/4" universal joint | 32 mm Bit adapter
 1/4" sq. x 1/4" hex | 25 mm
 1/4" bits in-hex 3 4 5 6 8 10 | 25 mm
 1/4" bits slotted 4 5.5 7 | 25 mm
 1/4" bits cross-head PH 1 2 3 4 | 25 mm
 1/4" bits cross-head PZ 1 2 3 | 25 mm
 1/4" bits TX T8 T10 T15 T20 T25 T27 T30 T40 | 25 mm
 1/2" 2C lever reversible ratchet, fine-toothed, 72 teeth | 250 mm
 1/2" socket hex
 10 11 12 13 14 15 16 17 18 19 20 21 22 23 24 26 27 28 30 32 mm
 1/2" socket extension 125 250 mm
 1/2" universal joint | 65 mm
 Socket extension piece/slider 3/8" x 1/2" | 44 mm
 Combination spanners 8 9 10 11 12 13 14 15 16 17 18 19 mm
 Hexagon Allen key set 1.5 2 2.5 3 4 5 6 8 10 mm
 Adjustable spanner 10" 250 mm
 Screwdriver slotted 4 5.5 6.5
 Screwdriver cross-head PH 1 2 3
 Side cutter 180 mm
 Telephone pliers 200 mm
 Water pump pliers 10" 250 mm
 Hammer 500 g





R4600 3092

1/4" + 1/2" SOCKET SET

92 pieces

> Ideal for all jobs with maintenance work, for trades people or in the workshop



Code	No.	Length mm	Width mm	Height mm	Pieces	Weight kg
330062	R46003092	383	280	83	92	5,85

Contents

1/4" 2C-Lever Change reversible ratchet fine-toothed, 72 teeth | 150 mm
 1/4" Square plug-in handle | 165 mm
 1/4" Socket 4 4.5 5 5.5 6 7 8 9 10 11 12 13 mm
 1/4" Socket 4 5 6 7 8 9 10 11 12 13 mm | 50 mm
 1/4" Socket extension 50 100 mm
 1/4" Sliding T Bar | 115 mm
 1/4" Universal joint | 32 mm
 Bit holder 1/4" hexagonal x 1/4" hexagonal, with magnet | 60 mm
 Bit adaptor 1/4" square x 1/4" hexagon | 25 mm
 Drive adaptor 1/4" hexagon x square with ball lock | 25 mm
 1/4" Bits hexagon socket 3 4 5 6 8 10 | 25 mm
 1/4" Bits slotted 4 5 5.7 | 25 mm
 1/4" Bits PH 0 1 2 3 4 | 25 mm
 1/4" Bits PZ 1 2 3 | 25 mm
 1/4" Bits TX T8 T10 T15 T20 T25 T27 T30 T40 | 25 mm
 5/16" Bits TX T45 T50 T55 | 30 mm
 1/2" 2C-Lever reversible ratchet fine-toothed, 72 teeth | 250 mm
 1/2" Socket
 10 11 12 13 14 15 17 19 22 24 27 30 32 mm
 1/2" Spark plug socket 21 mm (13/16") | 65 mm
 1/2" Socket extension 125 250 mm
 1/2" Universal joint | 65 mm
 Adaptor 3/8" x 1/2" | 44 mm
 Bit adaptor 1/2" square x 5/16" hexagon | 38 mm
 Double-jointed spanner 8x9 10x11 12x13 14x15 mm
 Combination spanner 8 10 12 13 14 17 mm
 Offset screwdriver hexagon 1.5 2 2.5 mm





R4600 3232

1/4"+1/2" SOCKET SET

232 pieces

> Ideal for all jobs for tradespeople or in the workshop

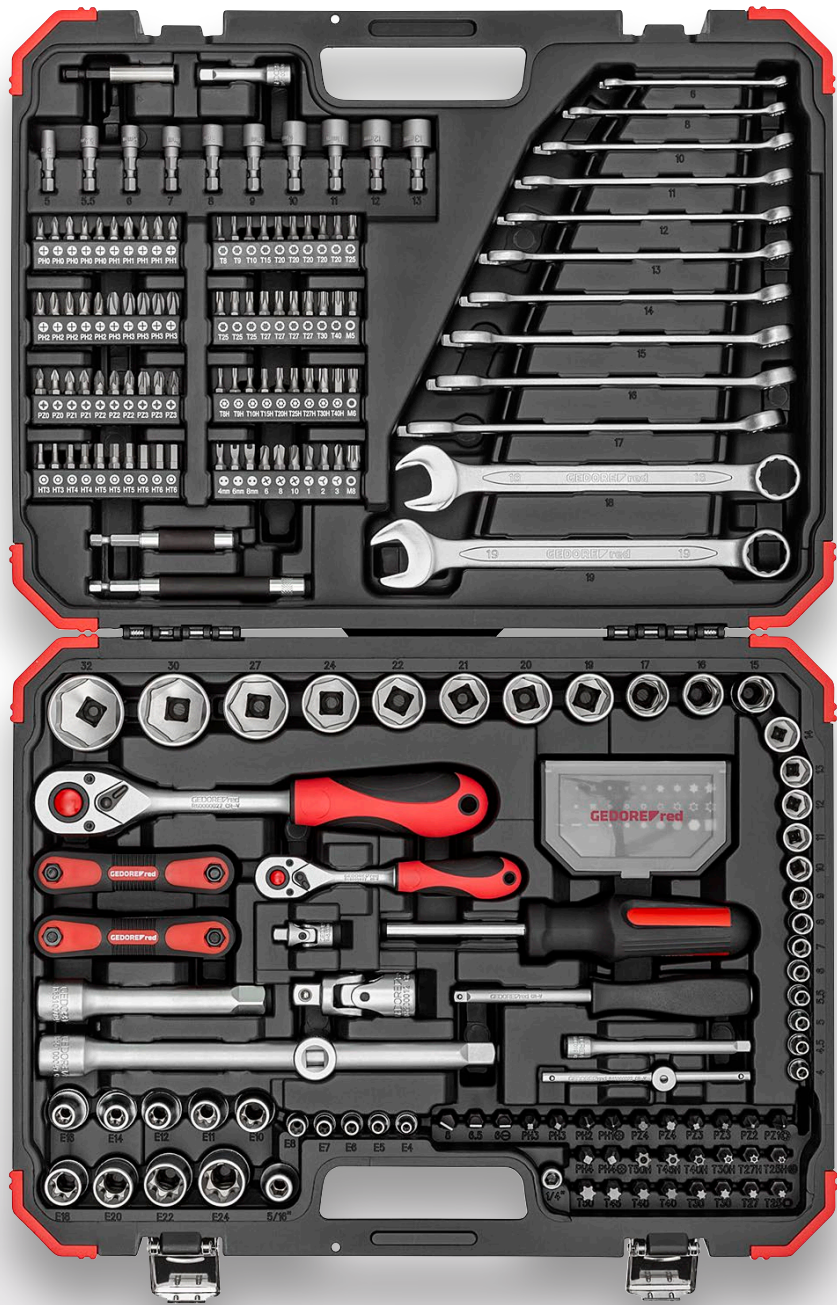

Code	No.	Length mm	Width mm	Height mm	Pieces	Weight kg
3300185	R46003232	452	340	86	232	8,9

Contents

2C-1/4" Reversible ratchet length 150 mm Return angle 5°, 2C-1/2" Reversible ratchet length 250 mm Return angle 5°
 1/4" Sockets 4 4.5 5 5.5 6 7 8 9 10 11 12 13 14 | 25 mm, 1/2" Sockets 15 16 17 19 20 21 22 24 | 38 mm
 1/2" Sockets 27 30 32 | 42 mm, 1/4" T-handle with slider
 1/4" Socket extension 50 100 mm, 1/2" Socket extension 125 - 250 mm
 1/4" Universal joint length 33 mm, 1/2" Universal joint length 66 mm, 1/4" Square socket handle 165 mm, 1/4" Sockets TX E4 E5 E6 E7 E8 | 25mm
 1/2" Sockets TX E10 E11 E12 E14 E16 E18 E20 | 38mm, E22 L 40mm, E24 L41mm
 Adator 3/8" x 1/2", 1/2" Bit adaptor square x 5/16" hexagon
 1/4" Bit screwdriver L 100 mm, 1/4" Bits 25 mm long: Hexagon socket 3 4 5 6, PH 5x 0 1 2 3 each, PZ 2x 0 1 each 3x 2 3, TX T8 T9 T10 T15 T20 T25 T27 T30 TXB T40 T9 T10 T15 T20 T25 T27 T30 T40 Spanner 5 6 8 XZN 4 6 8 TRI-WING 1 2 3 Torque 6 8 10
 1/4" Bits hex 38 mm long 5 5.5 6 7 8 9 10 11 12 13 mm, 1/4" Bit holder 60+80+120mm
 30-piece Bit box with 1/4" bits, 25 mm long: internal hexagon 2 3 4 5 5.5 6 mm, slot 4 5.5 6 mm,
 PH 1 2 3, PZ 1 2 3, TX T10 T15 5xT20 4xT25 4xT27 T30 T40, TXB T10 T15 T20 T25 T27 T30 T40
 5/16" Bits 30 mm long: slotted 6 6.5 8, PH 1 2 2x3 4 each, PZ 1 2 2x3 4 each, TX T25 T27 T30 T40 T45 T50, TXB T 25 T27 T30 T40 T5 T45
 Combination wrench 6 8 10 11 12 13 14 15 16 17 18 19 mm, Offset screwdriver 1.5 2.5 3 4 5 6 8 mm
 Offset screwdriver TX T9 T10 T15 T20 T25 T27 T30 T40, Insert holder 1/4" square x 1/4" hex length 25mm

R4560 3172

1/4" + 3/8" + 1/2" SOCKET SET

172 pieces

> Ideal for all jobs with maintenance work,
for trades people or in the workshop

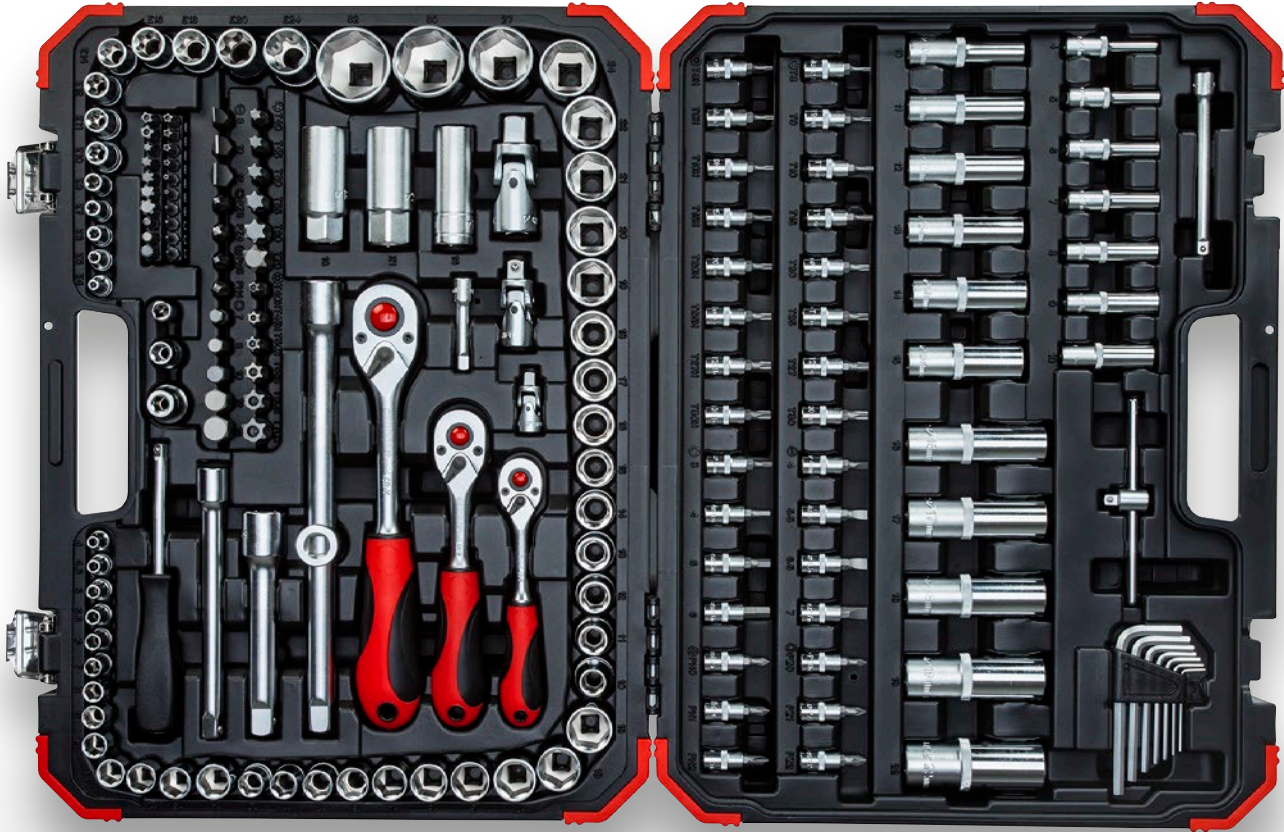

Code	No.	Length mm	Width mm	Height mm	Pieces	Weight kg
3300058	R45603172	450	345	93	172	10,5

Contents

1/4" 2C lever reversible ratchet, fine-toothed, 72 teeth | 150 mm, 1/4" square plug-in handle 165 mm, 1/4" socket wrench insert, hexagon SW 4 4.5 5 5.5 6 7 8 9 10 11 12 13 14 | 25 mm
 1/4" socket wrench insert hexagon SW 4 5 6 7 8 9 10 | 50 mm, 1/4" socket wrench insert TX E4 E5 E6 E7 E8 | 25 mm
 1/4" screwdriver bit socket hexagon socket 3 4 5 6 | 37 mm, 1/4" screwdriver bit socket slotted 4.5 5 6.5 7 | 37 mm
 1/4" screwdriver bit socket cross-slotted PH 0 1 2 | 37 mm, 1/4" screwdriver bit socket cross recess PZ 0 1 2 | 37 mm
 1/4" screwdriver bit socket TX T8 T9 T10 T15 T20 T25 T27 T30 | 37 mm, 1/4" screwdriver bit socket TX with bore T8 T9 T10 T15 T20 T25 T27 T30 | 37 mm
 1/4" socket wrench extension 50 100 mm 1/4" T-handle with slider | 115 mm, 1/4" universal joint | 32 mm bit adapter 1/4" square x 1/4" hex. | 25 mm
 1/4" bits TX T5 T6 T7 | 25 mm, 1/4" bits TX with hole T7 | 25 mm, 1/4" bits TX plus security T10 T15 T20 T25 T27 T30 T40 T45 | 25 mm
 1/4" bits multi-tooth XZN M5 M6 M8 | 25 mm, 1/4" bits keyway M5 M6 M7 M8 M9 | 25 mm
 5/16" bits hexagon socket 7 8 10 12 14 | 30 mm, 5/16" bits slotted 8 10 12 | 30 mm, 5/16" bits cross recess PH 3 4 | 30 mm, 5/16" bits cross recess PZ 3 4 | 30 mm
 5/16" bits TX T40 T45 T50 T55 T60 T70 | 30 mm, 5/16" bits TX with bore T40 T45 T50 T55 T60 T70 | 30 mm, 3/8" 2C lever reversible ratchet, fine-toothed, 72 teeth | 180 mm
 3/8" socket wrench insert hexagon SW 10 11 12 13 14 15 16 17 18 19, 3/8" socket wrench insert hexagon SW 10 11 12 13 14 15 | 63 mm, 3/8" socket wrench insert TX E10 E11 E12 E14 E16 E18
 3/8" spark plug insert SW 18 mm | 65 mm, 3/8" socket wrench extension 150 mm, 3/8" universal joint | 49 mm bit adapter, 3/8" square x 5/16" hex | 30 mm
 1/2" 2C lever reversible ratchet, fine-toothed, 72 teeth | 250 mm, 1/2" socket wrench insert hexagon SW 10 11 12 13 14 15 16 17 18 19 20 21 22 24 27 30 32
 1/2" socket wrench insert 6-kant SW 16 17 18 19 22 | 77 mm, 1/2" socket wrench insert TX E20 E24, 1/2" spark plug insert SW 16 21 mm | 65 mm
 1/2" socket wrench extension 125 250 mm, 1/2" universal joint | 66 mm, enlarging piece / sliding piece 3/8" x 1/2" | 44 mm
 bit adapter 1/2" square x 5/16" hex | 38 mm, offset screwdriver set hexagon SW 1.5 2.2 5.3 4 5 6 mm

R7800 4014

SOCKET SET 3/4"

14 pieces

> For hand-operated applications



Code	No.	Contents	Length mm	Width mm	Height mm	Pieces	Weight kg
3300011	R78004014	3/4" reversible ratchet, coarse-cogged, 24 teeth 510 mm 3/4" socket hexagon 22 24 27 30 32 36 38 41 46 50 mm 3/4" socket extensions 200 - 400 mm, 3/4" sliding T-bar with slider 460 mm	552	548	105	14	14,2

R6304 3003

1/2" IMPACT SOCKET SET

3 pieces

- > Specially for fitting / removing wheels of vehicles
- > Plastic sleeves for damage-free work on aluminium wheel rims
- > Colour coding for ease in identifying the right size
- > Square drive as per DIN 3121 - G 12,5, ISO 1174
- > Design according to DIN 3129, ISO 2725-2
- > Machine-operated, fixing with safety ring / pin



Code	No.	Length mm	Width mm	Height mm	Pieces	Weight kg
3300578	R63043003	158	135	52	3	0,83

Contents

Impact socket 17 19 21 mm | 86 mm

R6300 3008

IMPACT SOCKET SET 1/2"

8 pieces

- > Machine-operated, fixing with safety ring / pin
- > Square drive as per DIN 3121 - G 12,5, ISO 1174
- > Design according to DIN 3129, ISO 2725-2

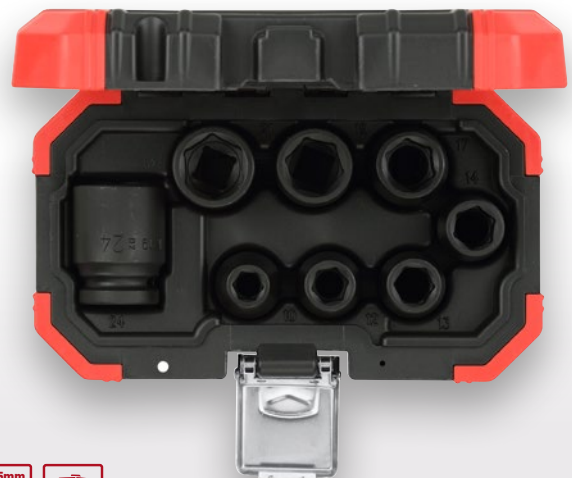

Code	No.	Length mm	Width mm	Height mm	Pieces	Weight kg
3300575	R63003008	190	110	52	8	1,1

Contents

Impact socket 10 12 13 14 17 19 21 24 mm

R6800 3030

SET OF SCREWDRIVER INSERTS 1/2" IN

30 pieces

- > For hand-operated applications
- > Long version

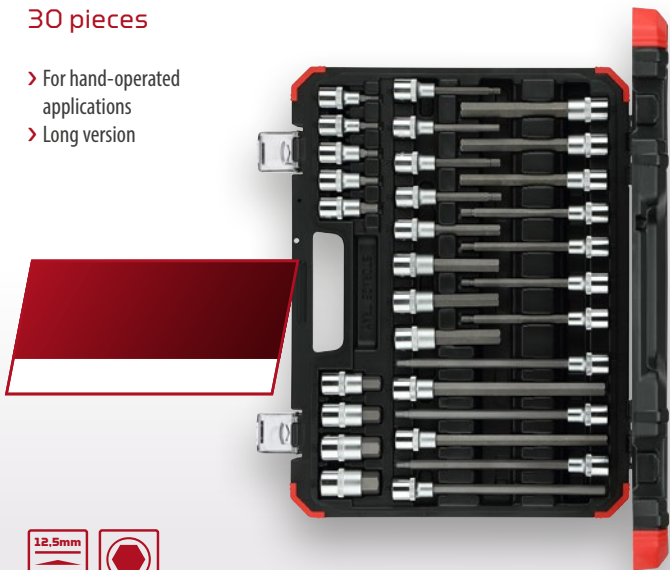

Code	No.	Length mm	Width mm	Height mm	Pieces	Weight kg
3301573	R68003030	425	325	56	30	5,4

Contents

Screwdriver bit socket in-hex, 5 6 7 8 10 12 14 17 19 | 55 mm
Screwdriver bit socket, in-hex 5 6 7 8 10 11 12 13 | 100 mm
Screwdriver bit socket in-hex 5 6 7 8 10 12 14 | 140 mm
Screwdriver bit socket in-hex, 5 6 7 8 10 12 | 200 mm

R6800 3032

SET OF SCREWDRIVER SOCKETS 1/2" TX

32 pieces

- > For hand-operated applications
- > Long version

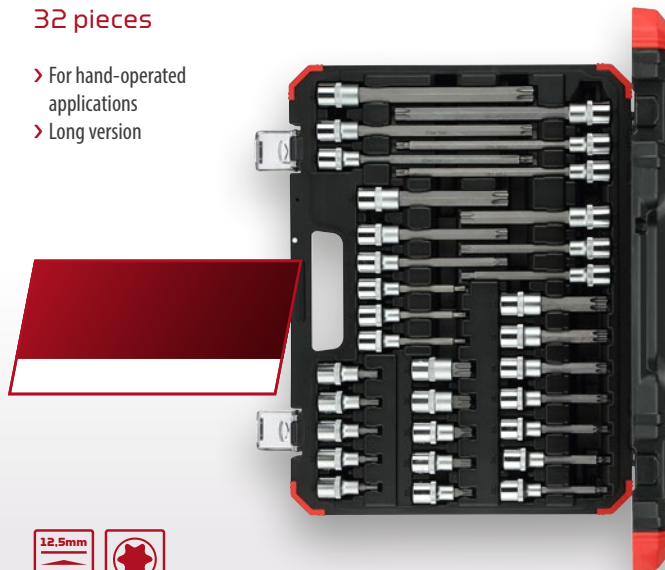

Code	No.	Length mm	Width mm	Height mm	Pieces	Weight kg
3301577	R68003032	425	325	56	32	5,4

Contents

Screwdriver bit socket TX T20 T25 T27 T30 T40 T45 T50 T55 T60 T70 | 55 mm
Screwdriver bit socket TX T20 T25 T27 T30 T40 T45 T50 T55 T60 T70 | 100 mm
Screwdriver bit socket TX T40 T45 T50 T55 T60 T70 | 140 mm
Screwdriver bit socket TX T40 T45 T50 T55 T60 T70 | 200 mm

R6800 3075

ASSEMBLY TOOL SET TX 1/4" + 1/2"

75 pieces

- > For hand-operated screw work



Code	No.	Length mm	Width mm	Height mm	Pieces	Weight kg
3301575	R68003075	383	272	80	75	3,5

Contents

1/4" socket TX E4 E5 E6 E7 E8 E10 E11 | 25 mm, 1/4" screwdriver bit socket TX T7 T8 T9 T10 T15 T20 T25 T27 T30, T40 | 37 mm, 1/4" bit adaptor square x hex | 25 mm
1/4" bits TX with hole T7 T8 T9 T10 T15 T20 T25 T27 T30 T40 | 25 mm, 1/2" socket TX E12 E14 E16 E18 E20 E22 E24, Bit adaptor 1/2" 4kt x 10 mm 6kt | 38 mm 10mm
bits TX T40 T45 T50 T55 T60 | 30 mm 10mm, bits TX T15 T20 T25 T30 T40 T45 T50 T55 T60 | 75 mm, Screwdriver TX T8x60 T10x80 T15x80 T20x100 T25x100 T27x125 T30x125 T40x150 mm
Double-ended ring spanner TX E6xE8 E10xE12 E14xE18 E20xE24, Hexagon socket key TX T8 T10 T15 T20 T25 T27 T30 T40 T45 T50 T55 T60, Telescopic magnetic lifter with scriber 126 - 636 mm

R6890 3011

WHEEL MOUNTING SET

11 pieces

- > The universal wheel mounting set impresses with precision and flexibility
- > Includes torque wrenches for cars /SUVs/vans with 40-200 Nm



Code	No.	Contents	Length mm	Width mm	Height mm	Pieces	Weight kg
3300400	R68903011	1/2" 2C-Telescopic ratchet 460-600 mm, 1/2" Socket extension 75 mm + 125 mm 1/2" Impact sockets, hexagon with protective sleeve 17 mm + 19 mm Tyre tread depth gauge red/black, Magnetic dish White tyre marking chalk, Wheel bolt bag red/black Blow-moulded storage case (520x280x100mm), Torque wrench 1/2" 40 - 200 Nm	540	290	145	11	5,7

R2170 2013

ON THE ROAD BIKE SET

13 pieces

- > Ergonomic handling with bit ratchet and bit adapter
- > Selection of bits and sockets tailored to the screws and nuts on a bike
- > Clampable bag on the saddle and seat post



Code	No.	Length mm	Width mm	Height mm	Pieces	Weight kg
3300194	R21702013	90	54	145	13	0,24

Contents

Tyre lever set, 3 pieces, Bit hexagon socket 3 4 5 6, Bit PH1, Bit TX T25
Socket 10 mm, Ratchet 1/4", Drive adaptor
Bit holder with quick release system 66.5 mm, Pocket



R2165 2057

TOOL CASE AZUBI L

57 pieces

- > Basic assortment for the most common applications such as screwing, loosening, cutting and measuring
- > Very robust case, pressure-, dust- and waterproof, also suitable for air travel
- > The 2 built-in gas struts hold the case open and prevent it from closing suddenly
- > Increased storage space thanks to tool compartments including pockets for improved organisation
- > Reinforced fastening eyelets for all types of padlocks



57-piece
assortment
for trainees



Sturdy and
water-tight case

Maximum overview and
effortless tool access

Code	No.	Contents	Length mm	Width mm	Height mm	Pieces	Weight kg
3301638	R21652057	Socket set 1/4", 33 pieces 4-13 mm 2C-Screwdriver slotted 3 4 5,5 mm 2C-Screwdriver PH1 PH2 Combination wrench set, 12 pieces 6-22 mm Wood sectioned folding ruler 2 m Class III 2C-Combination pliers 180 mm 2C-Side cutter 160 mm Water pump pliers 10", 7-way adjustable Spirit level 300 mm Engineer's hammer 300 g, 300 mm ash	485	212	414	57	10,82



R2165 2101

MASTER TOOL CASE XL

101 pieces

- > Complete tradesperson assortment for screwing, loosening, cutting, measuring and many more jobs and challenges on the building site
- > Ergonomic 2C carrying handle ensures easy and relaxed tool transport
- > The 2 integrated gas pressure springs keep the case open and protect it from sudden closing
- > Extra storage space with tool panels, including insert bag for clearer overview
- > Strengthened lugs for every kind of padlock



101-piece assortment
for construction and
maintenance work



Maximum
overview
and effortless
tool access

Sturdy and
water-tight case

Code	No.	Contents	Length mm	Width mm	Height mm	Pieces	Weight kg
3301639	R21652101	Bit-Box 1/4" 32 pieces, slot PH PZ TX hexagon Socket set 1/4", 46 pieces 4-14 mm Combination ratchet spanner set 5 pieces 8-19 mm 2C-Bit screwdriver 1/4" 100 mm, 2C-Screwdriver slotted 4 5,5 6,5 mm 2C-Screwdriver PH1 PH2, 2C-Screwdriver PZ1 PZ2 Voltage tester 220-250V slot 3,5 mm 2C-Combination pliers 180 mm, 2C-Power side cutter 180 mm Water pump pliers 10", 7-way adjustable, Flat chisel flat oval 200 x 24 x 13 mm Spatula 60 mm, Wood sectioned folding ruler 2 m Class III Spirit level 300 mm, Engineer's hammer 300 g, 300 mm ash	485	212	414	101	11,85



R2190 2124

TOOL TROLLEY MEISTER XXL

124 pieces

- > Complete range of tools for all common applications
- > Robust, dust and waterproof tool trolley equipped with 2 smooth-running castors and snap-in telescopic handle for easy transport of tools
- > The 2 built-in gas struts hold the case open and prevent it from closing suddenly
- > Increased storage space thanks to tool trays incl. pockets for improved organisation of the tools
- > Reinforced fastening eyelets for all types of padlocks



Sturdy and water-tight case with gas pressure springs

124 tools for construction and maintenance work

Extensive equipment with maximum overview



Code	No.	Length mm	Width mm	Height mm	Pieces	Weight kg
3301641	R21902124	550	225	350	124	14,12

Contents

Bit-Box 1/4" 32 pieces, slot PH PZ TX hexagon, Socket set 1/4", 46 pieces 4-14 mm, Combination ratchet spanner set, 5 pieces 8-19 mm
2C-Bit screwdriver 1/4" 100 mm, 2C-Screwdriver slotted 3 4 5,5mm, 2C-Screwdriver PH1 PH2, 2C-Screwdriver PZ1 PZ2, 2C-Screwdriver TX T15 T20 T25 T27
Offset screwdriver set, 9 pieces TX T10-T50, Offset screwdriver set, 9 pieces hex 1,5-10 mm, Voltage tester 220-250V slot 3,5 mm
2C-Power side cutter 200 mm, 2C-Combination pliers 200 mm, Water pump pliers 10", 7-way adjustable, Flat chisel flat oval 200x24x13mm
Spatula 60 mm, Utility knife 18 mm, Wood sectioned folding ruler 2 m Class III, Engineer's hammer 500g 320mm ash

R2190 2072

PLUMBERS TOOL TROLLEY

72 pieces

- > 72-piece tool assortment for all standard work in the plumbing, heating and air-con area
- > For mobile use, and for air transport
- > Sturdy, dust and water-tight tool trolley
- > Lockable with padlocks
- > Strengthened lugs for every kind of padlock
- > The 2 integrated gas pressure springs keep the case open and protect it from sudden closing



Extensive equipment with maximum overview

Sturdy and water-tight case with gas pressure springs

72 tools for sanitation-
heating-air conditioning



Code	No.	Length mm	Width mm	Height mm	Pieces	Weight kg
3301644	R21902072	550	225	350	72	14,97

Contents

Socket set 1/4", 33 pieces 4-13 mm, Screwdriver VDE PH1 PH2, Screwdriver VDE PZ1 PZ2, Screwdriver VDE slot 3x0.5x100 4x0.8x100 5.5x1x125
Offset screwdriver set, 9 pieces TX T10-T50, Offset screwdriver set, 9 pieces hexagon 1,5-10 mm, Voltage tester 220-250V slot 3,5mm
2C-Side cutter VDE 180 mm, Pipe cutter copper pipe-Ø 3-35 mm, Pipe wrench 1.1/2" 420 mm, Pliers wrench 10", Water pump pliers 10", 7-way adjustable
Flat chisel flat oval 250x25x13mm, Spatula 60 mm, Utility knife 18 mm
Hacksaw 150 mm, Wood sectioned folding ruler 2 m Class III, Spirit level 300 mm, Engineer's hammer 500 g 320 mm ash

R2165 2089

TOOL CASE ELECTRICIAN

89 pieces

- > Practical selection of tools for numerous installations on different systems (electrical)
- > Extremely sturdy case, pressure, dust and water-tight, also ideal for air travel
- > Optimum overview and access to the tool, sudden case closing prevented with gas pressure springs
- > Extra-big storage space and clearer overview with tool panels including insert bag
- > Lockable with padlocks



89 tools for working
on electrical systems

Extensive
equipment
with maximum
overview



Sturdy and water-tight case
with gas pressure springs



Code	No.	Length mm	Width mm	Height mm	Pieces	Weight kg
3301643	R21652089	485	212	414	89	12,54

Contents

Bit-Box 1/4" 32 pieces, slot PH PZ TX hexagon, Socket set 1/4", 33 pieces 4-13 mm, Combination ratchet spanner set, 5 pieces 8-19 mm
2C-Bit screwdriver 1/4" 100 mm, Screwdriver VDE slot 3x0.5x100 4x0.8x100 5,5x1x125, Screwdriver VDE PH1 PH2, Screwdriver VDE PZ1 PZ2
Voltage tester 220-250V slot 3,5mm, 2C-Side cutter VDE 180 mm, 2C-Telephone plier VDE 200 mm 45°, Wire stripper StrippMax-Auto
Water pump pliers 10", 7-way adjustable, Spatula 60 mm, Utility knife 18 mm, Wood sectioned folding ruler 2 m Class III, Spirit level 300 mm, Engineer's hammer 300 g 300 mm ash

R6011 0009

2C-1/2" SWIVEL-HEAD TELESCOPIC RATCHET

reversible

- > Ratchet head swivels through 180°
- > Ring for reversing clockwise/anticlockwise direction
- > For sockets, accessories etc. with square drive as per DIN 3120 - C 12,5, ISO 1174, with ball retention groove

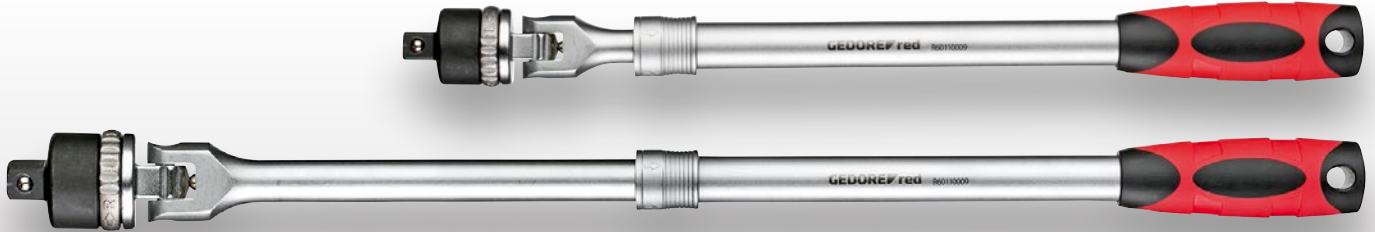

Code	No.	Square drive inch	Square drive mm	variable length mm	Return angle	Number of teeth	Weight kg
3300523	R60110009	1/2"	12,5	430-580	10°	36	1,292

R38X0 2006

SCREWDRIVER-SETS

- > Driven tips phosphated, corrosion-protected and low-wear
- > 2-component-handle for a hands-friendly transfer of force
- > 5-sided grip heads prevent rolling away

from



Code	No.	Pieces	Weight kg	excl. VAT
3301270	R38002006	6	0,435	

Contents

Screwdriver slotted 3 5.5 6.5 mm, Screwdriver PH 0 1 2

Code	No.	Pieces	Weight kg	excl. VAT
3301272	R38402006	6	0,55	

Contents

TX screwdriver T10 T15 T20 T25 T30 T40





RX890 XXXX
TORQUE WRENCHES
 5-300 Nm

- > Adjustable torque wrench with square drive and integrated ratchet function
- > Audible Torque triggering can clearly be heard and felt
- > Right-hand and left-hand tightening by changing the mushroom head / push-through square
- > Tripping accuracy: +/-3 % tolerance of the set scale value

from

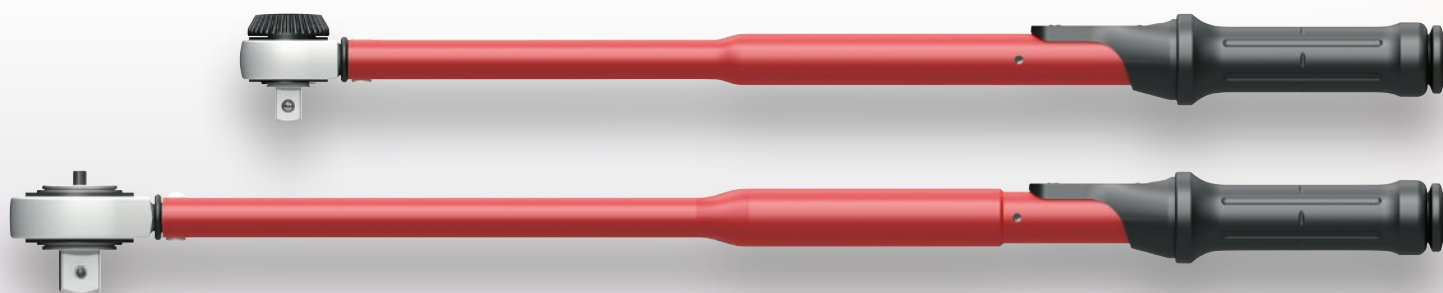

Code	No.	Type	Square drive inch	Square drive metric mm	Nm	vernier Nm	Height mm	Housing - square centre spacing mm	Length mm	Head width mm	Head height mm	Weight kg	excl. VAT.
3301214	R48900025	square socket with knob, serrated	1/4"	6,3	5-25	0,1	34	17,5	285	35,0	25,3	0,515	
3301871	R58900050	square socket with knob, serrated	3/8"	10	10-50	0,25	34	17,5	330	35,0	25,3	0,476	
3301216	R68900100	square socket with knob, serrated	1/2"	12,5	20-100	0,5	45	22	395	46,0	35,9	1,176	
3301217	R68900200	square socket with knob, serrated	1/2"	12,5	40-200	1	45	22	485	46,0	35,9	1,42	
3301218	R68900300	square socket with knob, serrated	1/2"	12,5	60-300	1	47	23	575	46,0	35,9	1,541	

R3660 1009 / R3640 1009

ALLEN KEY SET WITH COLOUR CODING

9 parts, long

The right
size in a jiffy

Offset and
straight screwing
with two heads



Comfortable working
with long handle

R3660 1009

ALLEN KEY SET HEX WITH COLOUR CODING

9 parts, long

- > Colour coded plastic coating to find the right L-key faster
- > Round shape
- > Long version with ball end
- > Folding holder with belt clip



Code	No.	Contents	Pieces	Weight kg
3301332	R36601009	1.5 2 2.5 3 4 5 6 8 10 mm	9	0,6

R3640 1009

ALLEN KEY SET TX WITH COLOUR CODING

9 parts, long

- > Colour coded plastic coating to find the right L-key faster
- > Round shape
- > Long version
- > Folding holder with belt clip



Code	No.	Contents	Pieces	Weight kg
3301333	R36401009	T10 T15 T20 T25 T27 T30 T40 T45 T50	9	0,52

R2015 2205

WORKSHOP TROLLEY GEDWORKER

with 5 drawers

- > Sheet steel, corrosion-resistant and scratch-resistant powder-coated
- > Working platform with cover made of ABS plastic with 3 compartments for small parts
- > Central locking system
- > Ball-bearing guide rails
- > All drawers can be pulled out on both sides
- > Load capacity per drawer 20 kg
- > Additional storage compartment for larger items below the last drawer
- > The GEDORE trapezoidal axle construction secures smooth running, manoeuvrability and track-keeping also in case of maximum loads



**Compact
organisation
helper**

**Flexible access
from 2 sides**

**Smooth-running
drawers**



Made in Austria



Code	No.	RAL	Length mm	Width mm	Height mm	Drawers	Max. load-bearing capacity kg	Number of drawers	Weight kg
3301675	R20152205	9005	685	462	963	2xType 1, H=74mm 3xType 2, H=119mm	200	5	41

R2156 2005

TOOL SET IN WORKSHOP TROLLEY GEDWORKER

119 pieces

- > As basic equipment for the workshop, basic range for beginners of all professional groups or the experienced
- > Metric dimension tools
- > Clearly arranged in GEDORE red foam modules
- > With check tool system: Completeness check using 2-colored foam inserts



**Sturdy body
and chassis**

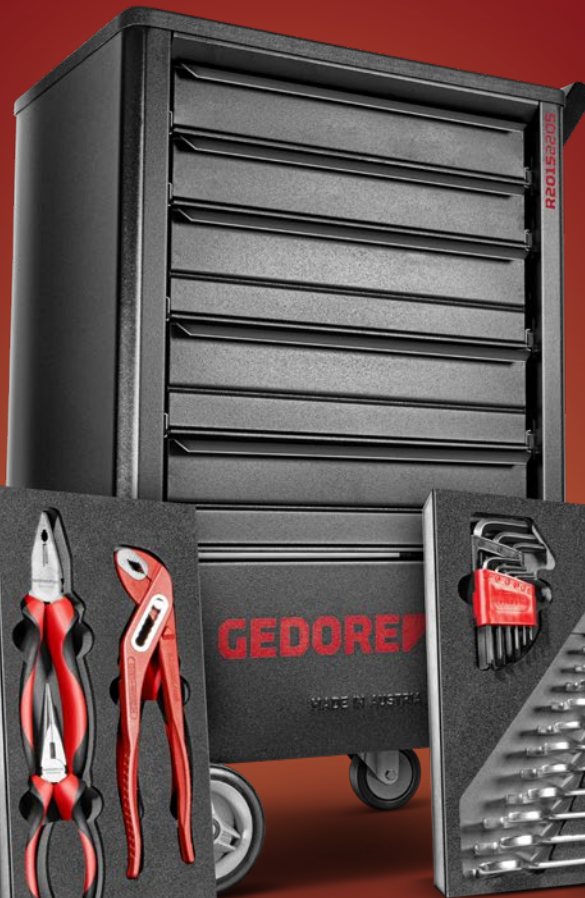

**Drawer access
from two sides**

**Smooth-running and
easy to manoeuvre,
even when fully loaded**



Made in Austria

**Equipped version
with 119 pieces**



Code	No.	Length mm	Width mm	Height mm	Pieces	Weight kg
3301676	R21562005	685	462	963	119	55,46

Contents

1/4" 2C-Lever reversible ratchet fine toothed, 72 teeth | 150 mm, 1/4" Driving handle 165 mm, 1/4" Socket hexagon 4 4,5 5 5,5 6 7 8 9 10 11 12 13
 1/4" Screwdriver bit socket for in-hex screws 3 4 5 6 8 10 | 37 mm, 1/4" Screwdriver bit socket slot 5,5 6,5 | 37 mm, 1/4" Screwdriver bit socket PH 1 2 3 | 37 mm
 1/4" Screwdriver bit socket PZ 1 2 | 37 mm, 1/4" Screwdriver bit socket TX with hole T10 T15 T20 T25 T27 T30 T40 | 37 mm, 1/4" Extension 100 mm
 1/4" Sliding T-bar with slider | 115 mm, 1/4" Universal joint | 32 mm, 1/2" 2C-Lever reversible ratchet fine toothed, 72 teeth | 250 mm, 1/2" Extension 125 250 mm
 1/2" Sliding T-bar with slider 250 mm, 1/2" Universal joint | 66 mm, 1/2" Socket hexagon 10 11 12 13 14 15 16 17 18 19 21 22 23 24 26 27 28 30 32
 1/2" Screwdriver bit socket for in-hex screws 6 7 8 9 10 12 14 | 55 mm, Screwdriver slotted 4 5,5 6,5 8 mm, Screwdriver PH 1 2, Screwdriver T10 T15 T20 T25 T30 T40
 Combination spanner 6 7 8 9 10 11 12 13 14 15 16 17 18 19 21 22 24 mm, Hexagon socket 1,5 2 2,5 3 4 5 6 8 10 mm, Engineer's hammer 300 g, Flat chisel 125 mm 150 mm
 Cross cut chisel 125 mm, Centre punch 4 mm | 120 mm, Pin punch 4 mm | 120 mm, Drift punch 3 mm | 150 mm, Water pump pliers 10" | 250 mm
 Combination pliers 180 mm, Telephone plier, gerade 160 mm, Side cutter 160 mm, Utility knife with 5 spare blades, Measuring tape 3 m

R2020 2207

WORKSHOP TROLLEY GEDMASTER

with 7 drawers

- > Sheet steel, corrosion-resistant and scratch-resistant powder-coated
- > Working platform with cover made of ABS plastic with 4 compartments for small parts
- > Side panels with Euro perforation 10 x 38 mm for attaching accessories
- > Central locking with cylinder lock
- > Each drawer with safety locking, single-hand operation
- > All drawers with full extension and ball bearing guide rails
- > Load capacity per drawer 40 kg
- > The GEDORE trapezoidal axle construction secures smooth running, manoeuvrability and track-keeping also in case of maximum loads



**Compact
organisation
helpers in the lid**

**400 kg load
bearing capacity**



7 drawers



Made in Austria



Code	No.	RAL	Length mm	Width mm	Height mm	Drawers	Max. load-bearing capacity kg	Number of drawers	Weight kg
3301677	R20202207	9005	790	470	999	5xType 1, H=70mm 2xType 2, H=145mm	400	7	65

R2207 1005

TOOL SET IN WORKSHOP TROLLEY GEDMASTER

273 pieces

- > Extensive range for industry, trade, automotive and the advanced do-it-yourselfer
- > Metric dimension tools
- > Clearly arranged in GEDORE red foam modules
- > With check tool system: Completeness check using 2-colored foam inserts



Safely loaded

High load bearing capacity

Easy to manoeuvre and smooth-running

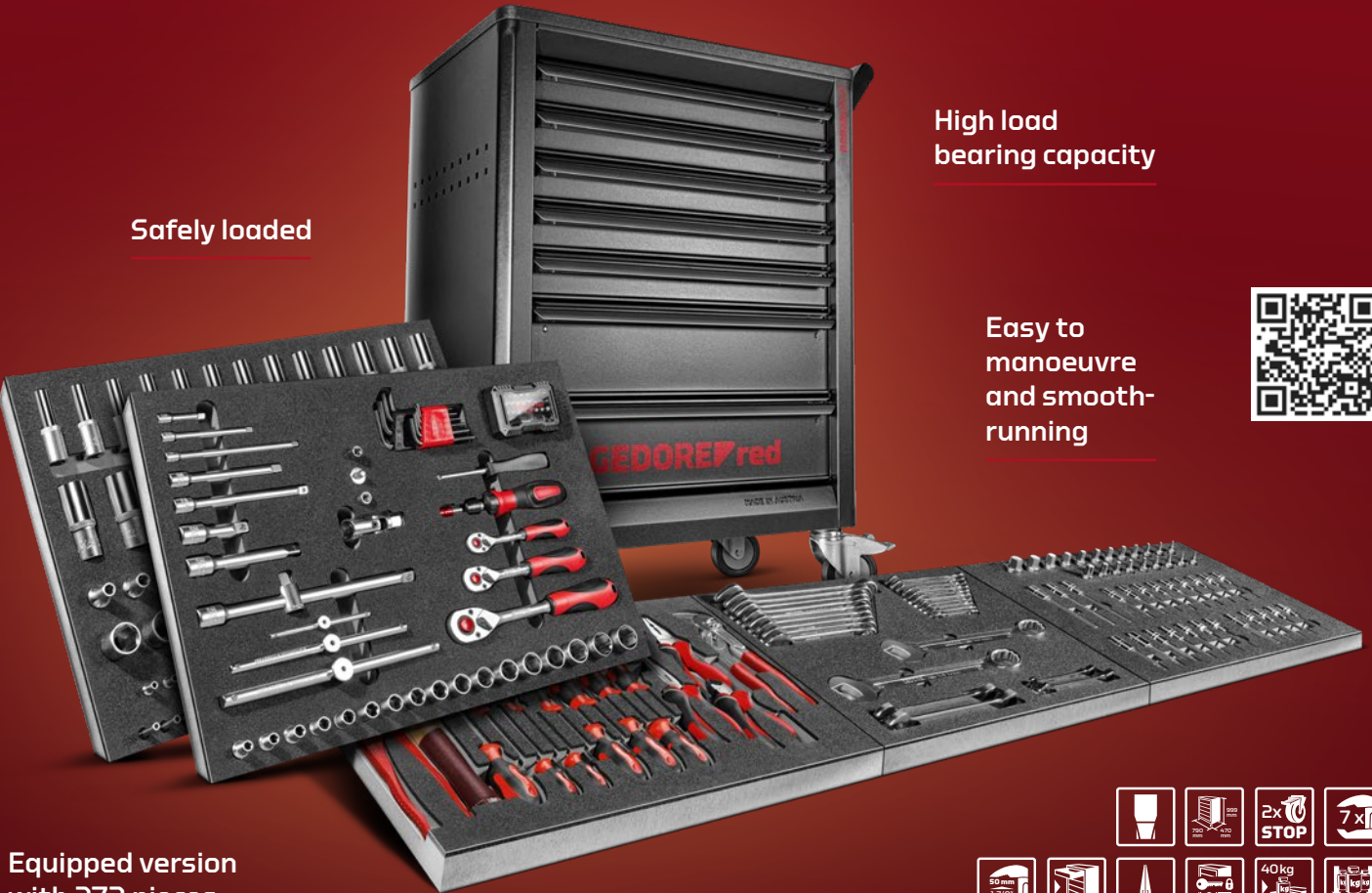

Equipped version with 273 pieces

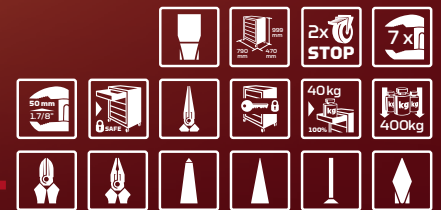

Code	No.	Length mm	Width mm	Height mm	Pieces	Weight kg
3301678	R22071005	790	470	999	273	88,5

Contents

Tool trolley GEDMaster 7 drawers, 1/4" 2C-Reversible ratchet L.150mm, 1/4" Extension L.50mm, 1/4" Extension L.100mm, 1/4" Extension L.150mm
 1/4" Sliding T-bar with slider L.115mm, 1/4" Universal joint L.33mm, 1/4" Driving handle L.62mm 2C-handle, 1/4" Bit-Adapter square x hexagon L.24.7mm
 1/4" Bit-Box SL+PH+PZ+TX+hexagon 32 pcs, 1/4" Ratchet screwdriver with telescopic blade, 3/8" 2C-Reversible ratchet L.180mm, 3/8" Socket hexagon 6 7 8 9 10 11 12 13 14 15 16 17 18 19 20 21 22
 3/8" Extension L.125mm, 3/8" Extension L.150mm, 3/8" Sliding T-bar with slider, Converter 3/8" x 1/2" square L.44mm, Reducer 3/8" to 1/4",
 1/2" 2C-Reversible ratchet L.250mm, 1/2" Universal joint L.66mm, 1/2" Extension L.75mm, 1/2" Extension L.125m, 1/2" Extension L.250mm
 1/2" Sliding T-bar with slider, Hexagon socket key set hexagon.5-10mm 9 pcs, 1/4" Socket hexagon 4 4.5 5 5.5 6 7 8 9 10 11 12 13 14 L.25mm
 1/4" Socket hexagon 4 4.5 5 5.5 6 7 8 9 10 11 12 13 L.50mm, 1/4" Socket TX E5 E6 E7 E8 E10 L.25mm, 1/4" Screwdriver bit socket 3 4 5 6 L.37mm,
 1/4" Screwdriver bit socket PH1 PH2 L.37mm, 1/4" Screwdriver bit socket PZ1 PZ2 L.37mm, 1/4" Screwdriver bit socket SC 5,5 6,5 L.37mm, 1/4" Screwdriver bit socket TX B0 T10 T15 T20 T25 T27 T30,
 1/4" Screwdriver bit socket TX T10 T15 T20 T25 T27 T30 T40, 1/2" Socket hexagon 8 9 10 11 12 13 14 15 16 17 18 19 20 21 22 24 27 32,
 1/2" Socket hexagon 10 11 12 13 14 15 16 17 18 19 20 21 22 24 27 30 32, 1/2" Socket TX E8 E10 E11 E12 E14 E16 E18 E20 E22 E24, 1/2" Spark plug socket 16 21
 1/2" Screwdriver bit socket 4 5 6 7 8 9 10 11 12 14 17 19 L.55mm, 1/2" Screwdriver bit socket 5 6 7 8 10 12 14 17 L.100mm,
 1/2" Screwdriver bit socket TX T20 T25 T27 T30 T40 T45 T50 T55 T60 L.55mm, 1/2" Screwdriver bit socket TX T20 T25 T27 T30 T40 T45 T50 T55 T60 L.100mm,
 1/2" Screwdriver bit socket XZN M5 M6 M8 M10 M12 M14 M16, Combination pliers L.180mm 2C-handle, Side cutter L.160mm 2C-handle, Telephone plier straight L.200mm
 2C-handle, 2C-Screwdriver slot 3 4 5,5 6,5, 2C-Screwdriver PH1 PH2, 2C-Screwdriver TX T10 T15 T20 T25 T30 T40, Water pump pliers 10", Engineer's hammer 300g L.300mm,
 Drift punch octagonal 120x4mm Ø12mm, Centre punch octagonal 120x4mm Ø10mm, Pin punch octagonal 150x4mm Ø10mm, Flat chisel flat oval 125x15x9mm, Flat chisel flat oval 150x18x11mm,
 Cross cut chisel flat oval, Pliers wrench 10", Combination spanner 6 7 8 9 10 11 12 13 14 15 16 17 18 19 20 21 22 24 27 30 32, Combination ratchet spanner 10 13 17 19

R2040 0006

TOOL TROLLEY MECHANIC PLUS

with 6 drawers

- > Large storage space with adjustable shelf, separately lockable
- > Strong, sheet steel construction, torsionally rigid, designed to take high loads
- > 988 x 431 mm working platform made of wood, 30 mm thick
- > 6 drawers with telescopic fully extending runners, with individual locking (one-hand operation)
- > The individual locking device - unlockable only with a practical, concealed release bar - prevents the drawer being opened when the trolley is in motion
- > Load capacity 25 kg per drawer, variable partitionable
- > 2 swivel casters Ø 100 mm of which one has a double-stop wheel lock, 2 castors Ø 140 mm, side projecting thus affording considerable stability



Code	No.	RAL	Length mm	Width mm	Height mm	Drawers	Max. load-bearing capacity kg	Number of drawers	Shelves	Worktop thickness mm	Weight kg
3301818	R20400006	3020 / 7016	988	431	935	4 x H 69 mm 1 x H 144 mm 1 x H 218 mm	210	6	1	30	81

R2156 0004

TOOL SET IN WORKSHOP TROLLEY MECHANIC

129 pieces

- > As basic equipment for the workshop, basic range for beginners of all professional groups or the experienced
- > Metric dimension tools
- > Clearly arranged in GEDORE red foam modules
- > With check tool system: Completeness check using 2-colored foam inserts



Code	No.	RAL	Length mm	Width mm
3301673	R21560004	3020 / 7016	628	418
Height mm	Number of drawers	Pieces	Weight kg	
910	6	129	68,1	

Contents

- 1/4" 2C-Lever reversible ratchet, fine-toothed, 72 teeth | 150 mm
- 1/4" Driving handle 165 mm
- 1/4" Socket hex 4 4,5 5 5,5 6 7 8 9 10 11 12 13 14 mm
- 1/4" Socket hex 4 4,5 5 5,5 6 7 8 9 10 11 12 13 mm | 50 mm
- 1/4" Screwdriver bit socket In-hex 3 4 5 6 8 10 | 37 mm
- 1/4" Screwdriver bit socket slot 5,5 6,5 | 37 mm
- 1/4" Screwdriver bit socket cross recess PH 1 2 3 | 37 mm
- 1/4" Screwdriver bit socket cross recess PZ 1 2 | 37 mm
- 1/4" Screwdriver bit socket TX with hole T10 T15 T20 T25 T27 T30 T40 | 37 mm
- 1/4" Socket extension 100 mm
- 1/4" Sliding T Bar | 115 mm, 1/4" Universal joint | 32 mm
- 1/2" 2C-Lever reversible ratchet, fine-toothed, 72 teeth | 250 mm
- 1/2" Socket hex 10 11 12 13 14 15 16 17 18 19 21 22 23 24 26 27 28 30 32 mm
- 1/2" Screwdriver bit socket In-hex 6 7 8 9 10 12 14 | 55 mm
- 1/2" Spark plug insert 16 21 mm | 65 mm
- 1/2" Socket extension 125 250 mm
- 1/2" Sliding T Bar | 250 mm, 1/2" Universal joint | 66 mm
- Adjustable wrench 8" 200 mm
- Combination ratchet spanner 8 9 10 11 12 13 14 15 16 17 18 19 20 22 mm
- Double open ended spanner 6x7 8x9 10x11 12x13 14x15 16x17 18x19 20x22 mm
- Combination pliers 180 mm
- Side cutter 160 mm, Flat nose pliers, straight 200 mm
- Screwdriver Slot 3 4 5,5 6,5 mm, Screwdriver cross recess PH 1 2
- Screwdriver TX T10 T15 T20 T25 T30 T40, Water pump pliers 10" 250 mm
- Engineer's hammer 300 g, Flat cold chisel 125 mm, 150 mm
- Cross-cut chisels 125 mm, Centre punch 4 mm | 120 mm
- Pin punch 4 mm | 120 mm, Drift punch 3 mm | 150 mm

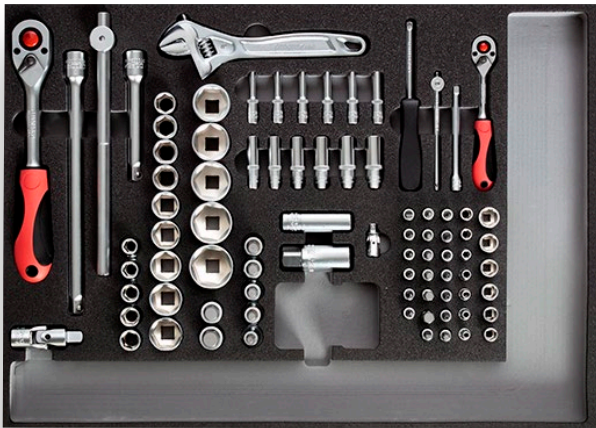

R2207 1004

TOOL SET IN WORKSHOP TROLLEY WINGMAN

129 pieces

- > As basic equipment for the workshop, basic range for beginners of all professional groups or the experienced
- > Metric dimension tools
- > Clearly arranged in GEDORE red foam modules
- > With check tool system: Completeness check using 2-colored foam inserts



Code	No.	RAL	Length mm	Width mm	Height mm
3301694	R22071004	3020/7016	470	724	1.034
Drawers		Max. load-bearing capacity kg	Number of drawers	Pieces	Weight kg
5x H = 83 mm		450	7	129	93,64
2x H = 155 mm					

Contents

1/4" 2C-Lever reversible ratchet, fine-toothed, 72 teeth | 150 mm, 1/4" Driving handle 165 mm
 1/4" Socket hex 4 4,5 5 5,5 6 7 8 9 10 11 12 13 14 mm
 1/4" Socket hex 4 4,5 5 5,5 6 7 8 9 10 11 12 13 mm | 50 mm
 1/4" Screwdriver bit socket In-hex 3 4 5 6 8 10 | 37 mm
 1/4" Screwdriver bit socket slot 5,5 6,5 | 37 mm
 1/4" Screwdriver bit socket cross recess PH 1 2 3 | 37 mm
 1/4" Screwdriver bit socket cross recess PZ 1 2 | 37 mm
 1/4" Screwdriver bit socket TX with hole T10 T15 T20 T25 T27 T30 T40 | 37 mm
 1/4" Socket extension 100 mm, 1/4" Sliding T Bar | 115 mm,
 1/4" Universal joint | 32 mm
 1/2" 2C-Lever reversible ratchet, fine-toothed, 72 teeth | 250 mm
 1/2" Socket hex 10 11 12 13 14 15 16 17 18 19 21 22 23 24 26 27 28 30 32 mm
 1/2" Screwdriver bit socket In-hex 6 7 8 9 10 12 14 | 55 mm
 1/2" Spark plug insert 16 21 mm | 65 mm, 1/2" Socket extension 125 250 mm
 1/2" Sliding T Bar | 250 mm, 1/2" Universal joint | 66 mm
 Adjustable wrench 8" 200 mm
 Combination ratchet spanner 8 9 10 11 12 13 14 15 16 17 18 19 20 22 mm
 Double open ended spanner 6x7 8x9 10x11 12x13 14x15 16x17 18x19 20x22 mm
 Combination pliers 180 mm
 Side cutter 160 mm, Flat nose pliers, straight 200 mm,
 Screwdriver Slot 3 4 5,5 6,5 mm
 Screwdriver cross recess PH 1 2, Screwdriver TX T10 T15 T20 T25 T30 T40
 Water pump pliers 10" 250 mm, Engineer's hammer 300 g, Flat cold chisel 125 mm, 150 mm
 Cross-cut chisels 125 mm, Centre punch 4 mm | 120 mm
 Pin punch 4 mm | 120 mm, Drift punch 3 mm | 150 mm





R9212 XXXX

ENGINEERS' HAMMER

with fibreglass

- > Forged hammer head
- > Striking surfaces inductively case-hardened for tough long-term work
- > Acc. to DIN 1041
- > DIN, manufacturer and weight marked for permanence
- > Nearly unbreakable fibreglass handle



from



Code	No.	Head weight g	Length mm	Weight kg	excl. VAT
3300722	R92120020	500	315	0,73	
3300723	R92120032	800	350	1,1	

R9000 0006

CHISEL & PUNCH SET

6 pieces

- > Tempered striking ends
- > Made from chrome-vanadium steel



Code	No.	Length mm	Width mm	Height mm	Pieces	Weight kg
3300826	R90000006	170	110	30	6	0,76

Contents

Flat cold chisel - length 125 150 mm, Cross-cut chisel - length 125 mm
Drift punch - Ø 3 mm, Centre punch - Ø 4 mm, Pin punch - Ø 4 mm

R9020 0106

PIN PUNCH SET

6 pieces

- > Acc. to DIN 6450
- > Tempered striking ends
- > Made of chrome-vanadium steel



Code	No.	Length mm	Width mm	Height mm	Pieces	Weight kg
3300824	R90200106	170	110	30	6	0,82

Contents

Pin punch Ø 3 4 5 6 8 10 mm

R3800 3043

TOOL SET „MEASURING-CUTTING-SCREWS“

43 pieces

> Ideal as basic equipment for tradespeople and DIYers

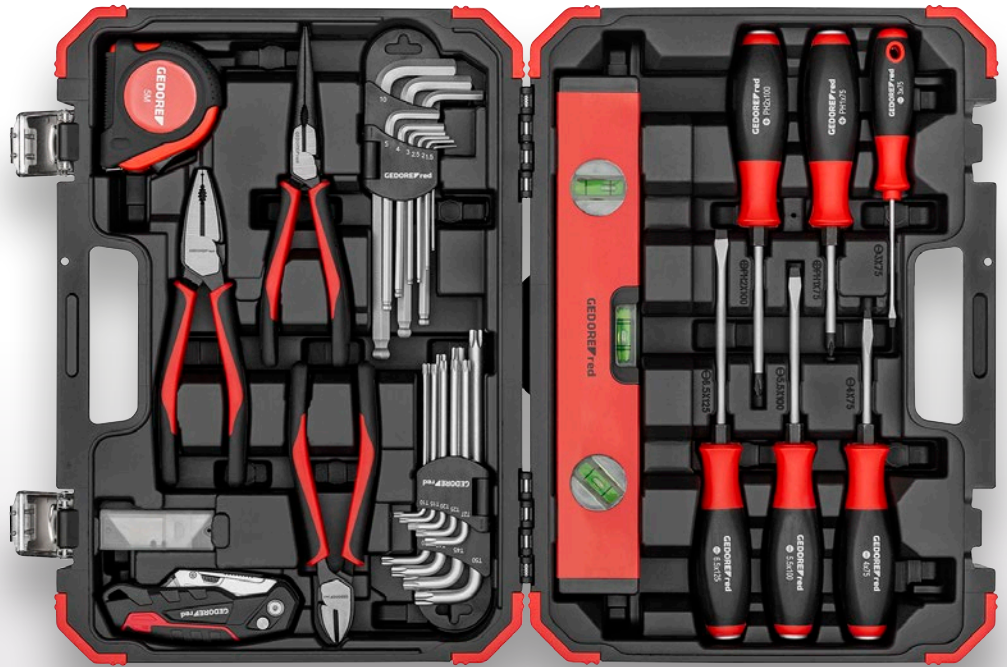

Code	No.	Contents	Length mm	Width mm	Height mm	Pieces	Weight kg
3300190	R38003043	Screwdriver slot 3 x 75 mm Screwdriver slot with striking cap 4x75 mm, 5.5x100 mm, 6.5x125 mm Screwdriver cross-recess PH with striking cap 1x75 mm, PH 2x100 mm Hexagon socket key 9 pcs. hexagon socket 1.5 2.2 2.5 3 4 5 6 8 10 long Offset screwdriver set 9 pcs TX T10 T15 T20 T25 T27 T30 T40 T45 T50, Roll tape measure, 5m Side cutters, Flat nose pliers straight, Combination pliers, Spirit level Cutter knife incl. 3 blades, 10 spare blades for cutter knife	383	272	80	43	6,2



R3900 2005

VDE TOOL ASSORTMENT

5 pieces

- > VDE-insulated acc. to DIN EN 60900
- > Guaranteed protection when working under voltage up to 1,000 V AC (alternating voltage) and 1,500 V DC (direct voltage)
- > 2-component-handle for a hands-friendly transfer of force



Code	No.	Pieces	Weight kg
3301414	R39002005	5	0,833

Contents
VDE Screwdriver slotted 3, 5.5 mm, VDE Screwdriver PH 2
VDE Side cutter 180 mm, VDE Telephone pliers 200 mm, straight pattern

R9530 0139

PEN LAMP

- > Ideal as a work lamp for mobile use
- > Protected against the ingress of small dust particles and splashing water
- > Good grip even with oily and sweaty hands
- > Can also be used with gloves
- > Practical clip for attaching to a belt, shirt pocket or trouser pocket



Good grip

Mobile companion

Great for outdoors



Code	No.	Luminous flux	Length mm	Width mm	Height mm	Weight kg
3301758	R95300139	130	139	15	15	0,056

R9520 0111

MINI WORK LAMP UV

- > 2-in-1: for applications with white and UV light
- > UV light, ideal for automotive use
- > Compact dimensions save space and weight
- > Two magnets ensure variable mounting options
- > Practical clip for attaching to a belt, shirt or trousers
- > Charging time: 3 h; lighting time: up to 7 h



2 in 1:
White and UV light

Compact size with 7
hours light output

Fixing with
magnet or clip



3 W LED	1100 lux	max. 340 lm	max. 7h	max. 7.5h
33 m	MAGNET	IK07	IP20	33 x 33 x 33 mm
108 g	Permanent (Hygro) Aluminium	USB-C	3h	LHlon

3.7 V | 2000 mAh | 7.40 Wh



Code	No.	Luminous flux	Length mm	Width mm	Height mm	Weight kg
3301763	R95200111	340	111,4	32,7	27,6	0,104

R9560 0320

INSPECTION LAMP

- > Ideal as a work lamp for mobile use in various areas
- > 5 switching functions for adjustable brightness
- > Magnet and 180° rotatable hook provide different holding options
- > Enables flexible and mobile use, as well as hands-free work



Optimum lighting

Always positioned right

Universal use

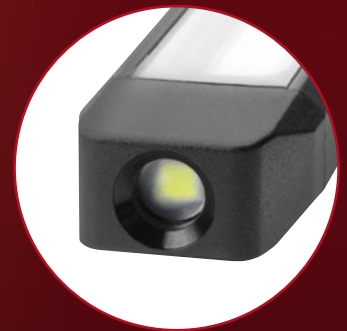

Code	No.	Luminous flux	Length mm	Width mm	Height mm	Weight kg
3301760	R95600320	500	320	33	43	0,26

R9540 0145

SPOTLIGHT

- > Compact, portable spotlight
- > Ideal for working in places without power supply
- > Shockproof and splash-proof rubberized border
- > 180° rotatable stand



Tough
as nails



Handy

Flexible positioning

Mobile use



Code	No.	Luminous flux	Length mm	Width mm	Height mm	Weight kg
3301761	R95400145	1.400	145	40	145	0,453

R9550 0058

HEADLAMP 260

- > 4 light levels (50-260 lm)
- > Sturdy ABS housing
- > Charging time: 4 h; lighting time: up to 9 h
- > Gesture control for contactless switching on & off
- > Elastic headband, individually adjustable, easy take-off



4 light levels

Elastic headband



Short charging time, long lighting time

Contactless switching on and off



					3.7 V 1200 mAh 4.44 Wh			



Code	No.	Luminous flux	Luminous duration h	Length mm	Width mm	Height mm	Weight kg
3301762	R95500058	260	up to 9	58	37	44	0,052

R9325 0008

POCKET KNIFE

2C handle

- > With sawing function for fibrous materials e.g ropes and textiles
- > 2-component-handle, PP and TPR
- > Feels good in the hand thanks to the anti-slip handle shape/structure



Code	No.	Blade length mm	Total length mm	Weight kg
3301615	R93250008	87	210	0,154

R9330 0031

UNIVERSAL SCISSORS

- > Suitable for cutting seals and other materials (paper, cardboard, foil, leather etc.)
- > Additional small blade for thin wires and cables
- > With wire stripper for 1.0, 1.5 and 2.0 mm cables



Code	No.	Total length mm	Weight kg
3301607	R93300031	205	0,19

R2714 0015

ELBOW PIPE WRENCH

S-jaw

- > Acc. to DIN 5234
- > Mouth position 45° angled
- > Teeth offset against direction of rotation
- > Jaws polished



Code	No.	Size	Pipe-Ø	Length mm	Weight kg
3301168	R27140015	1.1/2	55	420	1,46

R2720 2003

CURVED JAW LOCKING

PLIERS SET

3 pieces

- > For clamping and gripping profiled, round and flat-section material
- > Lengthways-serrated grip surfaces
- > With adjusting screw and release lever
- > One-handed operation



Code	No.	Contents	Pieces	Weight kg
3301180	R27202003	7" 10" 12"	3	1,95

R6800 3010
EXTRACTOR SET 1/2"
 10 pieces

- > For slackening and removing bolts and damaged screws
- > Anticlockwise cutting thread with 6 cutting edges tapering together
- > Square drive as per DIN 3120 - C 12,5, ISO 1174, with ball retention groove



12.5mm
1/2"

Code	No.	Length mm	Width mm	Height mm	Pieces	Weight kg
3300034	R68003010	130	130	55	10	0,95

Contents
 Extractor 1/2" 10 11 12 13 14 15 16 17 19 mm | 34 mm Chuck | 80 mm

R9300 0006
KEY FILE SET
 6 pieces

- > With wooden handle
- > Made of special steel



Code	No.	Contents	Pieces	Weight kg
3301596	R93000006	Triangular file Flat file Round file, Half-round file Square file	6	0,85

R9350 0170
TWIST DRILL BIT SET, ROLLED
 170 pieces

- > HSS twist drills DIN 338, type N, right-hand cutting
- > Tip angle: 118°



Code	No.	Contents	Length mm	Width mm	Height mm	Pieces	Weight kg
3301612	R93500170	each 10x Twist drill bit, rolled 1.0 1.5 2.0 2.5 3.0 3.5 4.0 4.5 5.0 5.5 6.0 6.5 7.0 7.5 8.0 mm each 5x Twist drill bit, rolled 8.5 9.0 9.5 10.0 mm	335	240	54	170	3,724

GEDORE

TOOLS FOR LIFE

GEDORE Werkzeugfabrik GmbH & Co. KG

Remscheid Straße 149
42899 Remscheid · GERMANY
Tel. + 49 (0) 21 91-596 - 0
Fax + 49 (0) 21 91-596 - 230
info@gedore.com
www.gedore.com

Vertrieb Deutschland
Tel. + 49 (0) 21 91-596 - 900
Fax + 49 (0) 21 91-596 - 999

GEDORE Automotive GmbH

Breslauer Straße 41
78166 Donaueschingen · GERMANY
Tel. +49 771 83223-0
Fax +49 771 83223-90
info.gam@gedore.com
www.gedore-automotive.com

GEDORE Torque Solutions GmbH

Bertha-Benz-Straße 12
71665 Vaihingen/Enz · GERMANY
T +49 7042 9441-0
F +49 7042 9441-41
torque-solutions@gedore.com

GEDORE AUSTRIA GmbH

Gedore-Str. 1
8190 Birkfeld / Stmk. · AUSTRIA
Tel. +43 (0) 3174 / 363 64 00
Fax +43 (0) 3174 / 363 83 20
sales.austria@gedore.com
www.gedore.at

GEDORE Tools S.A. (Pty) Ltd.

103 Qashana Khuzwayo (Shepstone) Road,
New Germany, 3610 - South Africa
PO Box 68, New Germany, 3620
SOUTH AFRICA
Tel. +27 (0) 31 / 705 3587
Fax +27 (0) 31 / 705 32770
esales@gedore.co.za
www.gedore.co.za

GEDORE IBÉRICA S.L.

c/Arangutxi 12, Poligono Industrial de Júndiz
01015 Vitoria Alava · SPAIN
Tel. +34-945-29 22 62
Fax +34-945-29 21 99
gedore@gedore.es
www.gedore.es

GEDORE Torque Ltd

(Formerly Gedore UK)
Tannery Lane, Gosden Common
Bramley, Guildford
Surrey
GU5 0AJ · UNITED KINGDOM
Tel. +44 (0) 1756 / 70 67 00
sales@gedoreuk.com
www.gedoreuk.com

GEDORE France SARL

Parc d'activités des Béthunes - La Mare II
10, avenue du Fief - Bât. 12
BP 79144 Saint-Ouen-l'Aumône
F-95074 Cergy Pontoise Cedex · FRANCE
Tél. +33 (0)1 34 40 16 60
Fax +33 (0)1 34 40 16 61
jadore@gedore.fr
www.gedore.fr

GEDORE TECHNAG B.V.

Flemingweg 7, 2408 AV
Alphen aan den Rijn · NETHERLANDS
Tel. +31 (0) 172 / 42 73 50
Fax +31 (0) 172 / 42 73 60
info@gedore.nl
www.gedore.nl

GEDORE (INDIA) Private Limited

148, Sector 3, IMT Manesar
Gurgaon - 122051
Haryana · INDIA
Tel. +91 (0) 124 22910 - 65/66/67
Fax +91 124 2341067
sales@gedoreindia.com
www.gedore.in

GEDORE POLSKA Sp. z o.o.

ul. Żwirki i Wigury 56a
43-190 Mikołów · POLAND
Tel. +48 (0) 32 / 738-40 10
Fax +48 (0) 32 / 738-40 20
gedore@gedore.pl
www.gedore.pl

Ferramentas GEDORE do Brasil S.A.

Rua Vicentina Maria Fidélis,
275 Bairro Vicentina
São Leopoldo - RS | 93025-340 · BRAZIL
Tel. +55 51- 3589 9200
Fax + 55 51- 3589 9222
export@gedore.com.br
www.gedore.com.br

GEDORE TOOLS

300 Langner Rd
Suite 250
West Seneca, NY 14224 · USA
Phone: +1 (843) 225 5015
Fax: +1 (843) 300 0315
info@gedoretools.com
www.gedoretools.com

GEDORE Tool Trading (Shanghai) Co., Ltd.

1/F, Block 2, 1358 Pingan Road,
Minhang, Shanghai · CHINA 201109
Tel. +86-21-3388 7258
Fax +86-21-3388 7259
Service Hotline: 400 880 1858
info@gedore.cn
www.gedore.cn

Your dealer / stamp:

Brands of the GEDORE Group
gedore.com · ochsenkopf.com

IMPULSE TOOL PROMOTION valid
from 01/03/2025 until 31/12/2025.
While stocks last.

*Special net prices per pc./set, plus VAT Delivery without decoration.
Technical specifications subject to modifications. No liability for printing errors.
Prices exclude VAT / for resellers only. Please ask your local dealer.

gedore.com